



Agenda EDHS Donation Fund Ad Hoc Committee Meeting

Tuesday, June 30, 2026 - 11:00 a.m.
Virtual Via Zoom

1. Call to Order

*****NOTICE - The EDHS Donation Fund Ad Hoc Committee Meeting of June 30, 2026 will be held virtually only. No in-person option will be available.**

Residents are provided the following option to watch the meeting:

1) Join the Zoom meeting using the following link: <https://springwater-ca.zoom.us/j/87101017573?pwd=45WkQBUBg8tRaYNruj9cvV6uC16pcb.1> and the following Meeting ID 871 0101 7573 and Passcode 700052. This option will only be available for the duration of the meeting.

2) Listen in to the meeting live from a telephone or cellular device by calling 1-647-558-0588 and using the following Meeting ID 871 0101 7573 and Passcode 700052. This option will only be available for the duration of the meeting.

1.1. Call to Order

Recommendation

That this meeting of the Elmvale District High School Donation Fund Ad Hoc Committee come to order at _____ p.m.

2. Disclosure of Pecuniary Interest

3. Previous Minutes

3.1. Approval of Minutes from March 12, 2026

3 - 5

Recommendation

That the March 12, 2026 Minutes of the Elmvale District High School Donation Fund Ad Hoc Committee be approved as presented.

[Minutes of the Elmvale District High School Donation Fund Ad Hoc Committee of March 12, 2026](#)

4. New Business / Reports for Discussion

4.1. Fit Trail

6 - 28

Recommendation

That the Elmvale District High School Fit Trail Proposal be received as information and;

That the Committee request Staff plan a Public Information Centre on _____ at _____ to seek public feedback on the Proposal; and

That notice of the Committee's Fit Trail PIC be provided to Council at the July 8, 2026 Regular Council meeting.

[Elmvale District High School Fit Trail Proposal](#)

5. Other Business

This item provides members with the opportunity to discuss business that doesn't require immediate action to be taken by the Committee, and raises a possible issue for further discussion at a future meeting. Members can also provide general information items that they would like to share under Other Business.

6. Information Items

6.1. That the information items listed herein be received for information:

29 - 30

1. Memo regarding Campaigning at Municipal Events or on Municipal Property

[1. Memo regarding Campaigning at Municipal Events or on Municipal Property](#)

7. Adjournment

7.1. Adjournment

Recommendation

That the June 30, 2026 meeting of the Elmvale District High School Donation Fund Ad Hoc Committee does now adjourn at _____ a.m.

8. Next Meeting

8.1. Next Meeting is scheduled for TBD.



Minutes

EDHS Donation Fund Ad Hoc Committee Meeting

Thursday, March 12, 2026 - 2:00 p.m.
Springwater Room, Elmvale Arena - 14 George Street, Elmvale, ON

Present:

Councillor Ward 1 Matt Garwood
Councillor Ward 2 Danielle Alexander
Community Member at Large Lindsay Burke
EDHS Rep Mark Ruzyllo
SCDSB Rep Corry Van Nispen

Also Present:

Briana Dean, Manager of Community Services
Dean Collver, Director of Recreation, Parks & Facilities
Katja Awender, Legislative / Records Coordinator

Regrets:

Community Member at Large George Allen

1. Call to Order

1.1. Call to Order

Resolution

Moved by Van Nispen
Seconded by Burke

That this meeting of the Elmvale District High School Donation Fund Ad Hoc Committee come to order at 2:14 p.m.

Carried

2. Disclosure of Pecuniary Interest

Nil.

3. Previous Minutes

3.1. Approval of Minutes from January 14, 2026

Resolution

Moved by Van Nispen
Seconded by Burke

That the January 14, 2026 Minutes of the Elmvale District High School Donation Fund Ad Hoc Committee be approved as presented.

Carried

4. New Business / Reports for Discussion

4.1. Delegation - Chantal Nelson

Member Ruzylo arrived at 2:19 p.m.

Resolution

Moved by Van Nispen

Seconded by Burke

That the written delegation from Chantal Nelson be received as information,
and

That the Committee request Staff provide a written response to the delegate.

Carried

4.2. Fit Trail Concept

Nil.

4.3. Bike Racks and Bike Repair Station(s) in Elmvale

Nil.

5. Other Business

Chair Garwood provided the Committee with a verbal update on the balance of the EDHS Fundraising Efforts Account.

6. Information Items

Nil.

7. Adjournment

7.1. Adjournment

Resolution

Moved by Burke

Seconded by Alexander

That the March 12, 2026, meeting of the Elmvale District High School Donation Fund Ad Hoc Committee does now adjourn at 2:39 p.m.

Carried

8. Next Meeting

8.1. Next Meeting is scheduled for TBD.

Councillor Matt Garwood, Chair

Katja Awender, Legislative/Records Coordinator

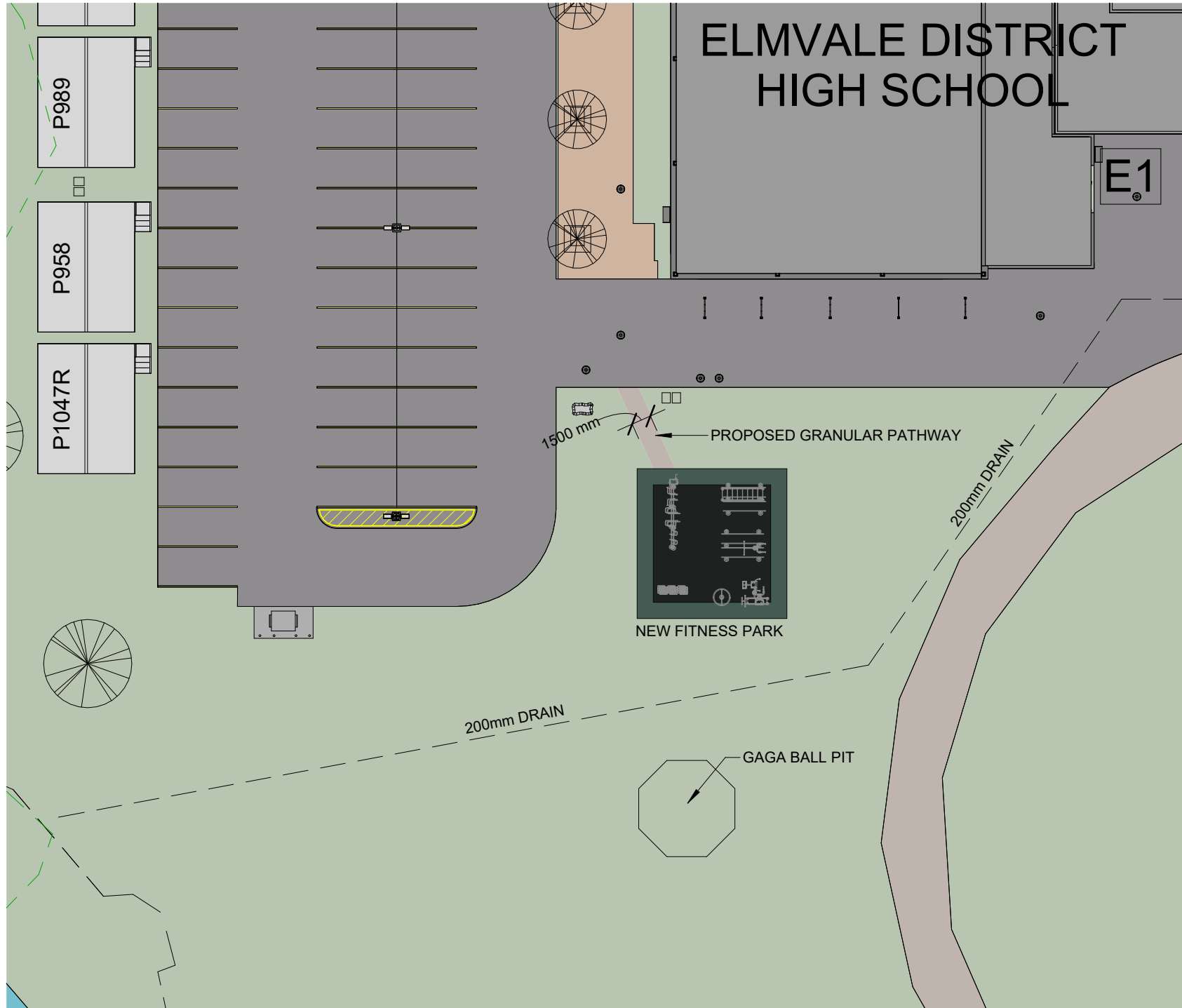

1
A1 PROPOSED FITNESS PARK
N.T.S.

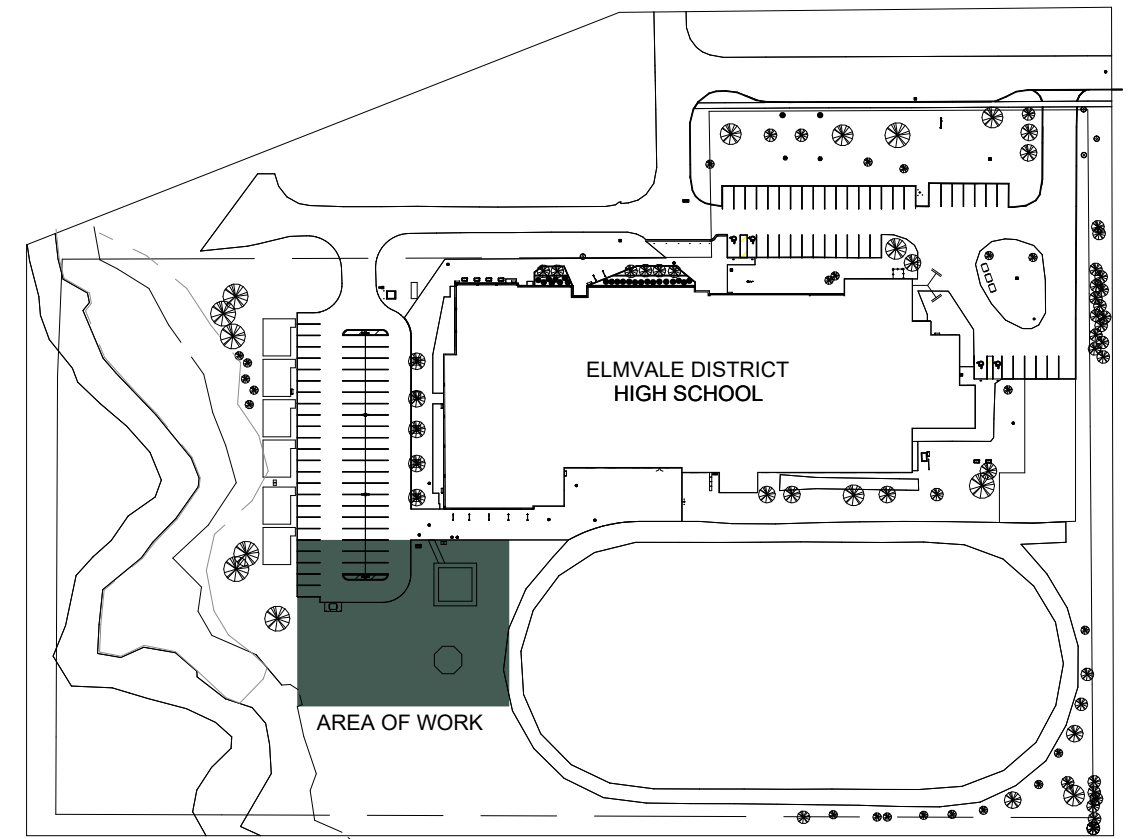

2
A1 KEY PLAN
N.T.S.

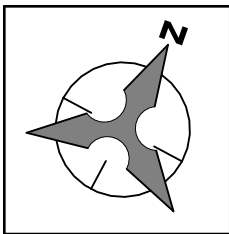

PROJECT TITLE:
ELMVALE DISTRICT HIGH SHCOOL
25 LAWSON AVENUE, ELMVALE, ON. L0L 1P0

DRAWING TITLE:
PROPOSED FITNESS PARK

Simcoe County
District School Board
Your Future... Our Priority

SCALE:
N.T.S.
DATE:
05/22/26

DRAWN BY:
JK

REVIEWED BY:
DC

DWG:

APPROVED BY:
S.C.D.S.B.

COMMISSIONED:

A1

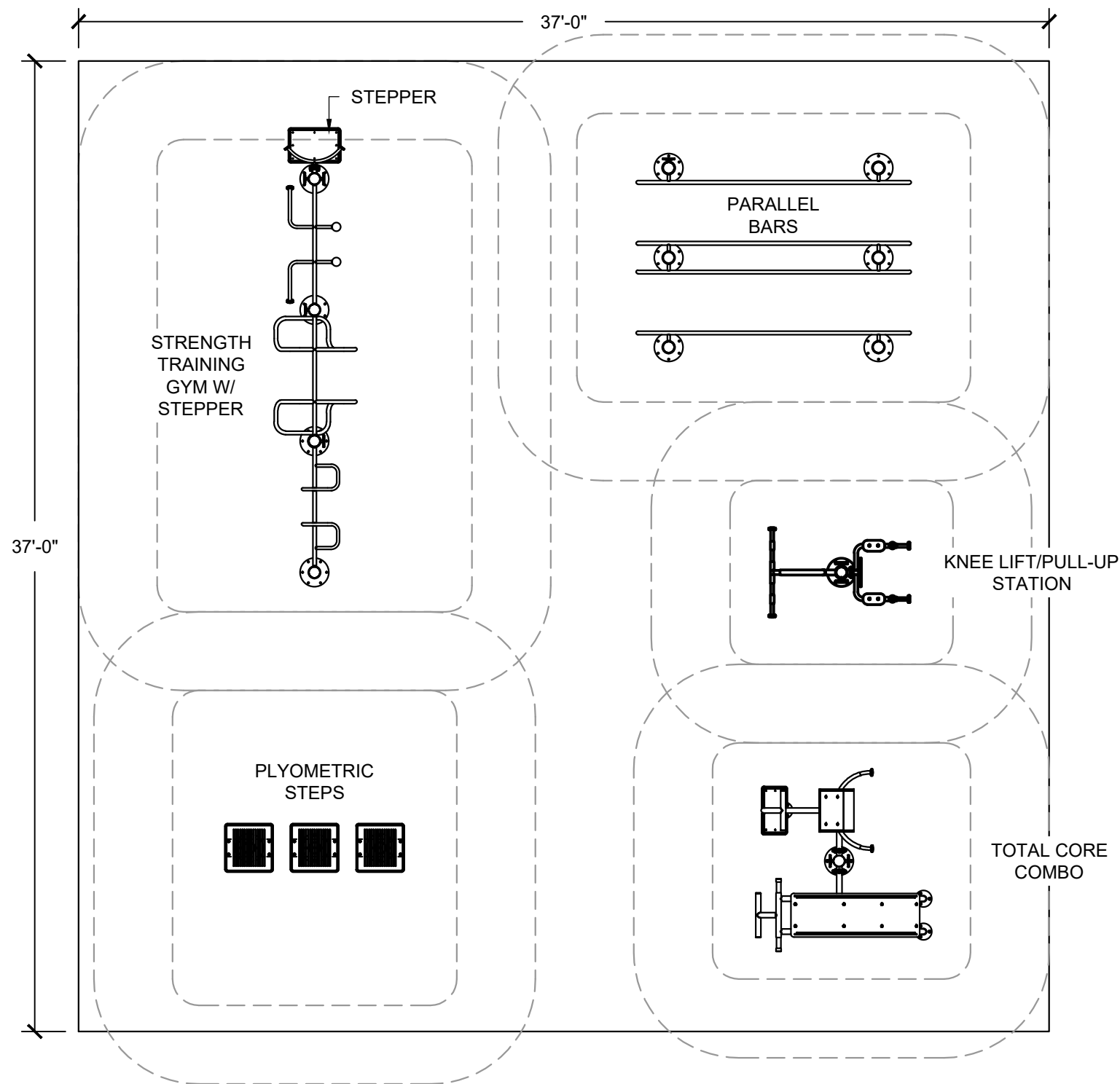

Elmvale Fitness Park	
Budget	
Construction Costs	\$ 135,000.00
Site Works - labour	\$ 35,000.00
Site Works - materials	\$ 25,000.00
Site Works - equipment	\$ 10,000.00
Safety Flooring	\$ 40,000.00
Fitness Equipment	\$ 25,000.00
Contingency (10%)	\$ 13,500.00
Professional Costs (20%)	\$ 27,000.00
Miscellaneous	\$ 5,000.00
HST	\$ 3,898.80
Total	\$ 184,398.80

QUOTATION: 3572_DGH6

June 1, 2026 at 12:32 pm

BILLING ADDRESS	DELIVERY ADDRESS
<p><u>Daniele Colbourne</u> Principle ☎ 705-322-2201 ☏ 249-733-1302 ✉ dcolbourne@scdsb.on.ca</p> <p><u>Scdsb Elmvale District High School</u> 25 Lawson Avenue Elmvale, Ontario L0L 1P0 Canada</p>	<p><u>Daniele Colbourne</u> Principle ☎ 705-322-2201 ☏ 249-733-1302 ✉ dcolbourne@scdsb.on.ca</p> <p><u>Scdsb Elmvale District High School</u> 25 Lawson Avenue Elmvale, Ontario L0L 1P0 Canada</p>

PLAYGROUND

QTY	ID	NAME	TOTAL
1	FIT-000027	Plyometric Steps	\$1,358.90
3	FDN-000003	Post Extension - Ø5 Inch	\$525.00
1	FDN-000004	Post Extension - Ø3.5 Inch	\$90.00
4	FDN-000003	Post Extension - Ø5 Inch	\$700.00
1	FIT-000022	Parallel Bars	\$3,870.00
6	FDN-000004	Post Extension - Ø3.5 Inch	\$540.00
1	FIT-000026	Knee Lift / Pull-Up Station	\$2,440.00
1	FDN-000003	Post Extension - Ø5 Inch	\$175.00
1	FIT-000025	Total Core Combo	\$4,270.00
1	FDN-000003	Post Extension - Ø5 Inch	\$175.00
3	FDN-000007	Post Extension - Ø2.375 Inch	\$237.00
1	CUS-410597	Srength Training Gym With Stepper	\$5,550.00
1	KIT-111111	Installation Kits	\$1059.01
1	SHI-111111	Estimated Shipping (Freight Delivery Only; Customer Responsible For Unloading)	\$3,308.13
Total Before Tax:			\$24,298.04

Quotation Notes

Scope of Work

This quote includes the supply and delivery of the following ActiveFit outdoor fitness equipment:

- Plyometric Steps
- Parallel Bars
- Knee Lift / Pull-Up Station
- Total Core Combo
- Strength Training Gym with Stepper

Installation

- Installation is not included.
- All equipment specified is designed for post-in-concrete installation.
- Required installation hardware, concrete kits, and post extensions are included with the equipment.

Exclusions

- Installation and supervision
- Excavation and concrete supply
- Site preparation and grading
- Safety surfacing
- Permits, inspections, and utility locates
- Removal of existing equipment or site amenities

Lead Time

Estimated lead time is 10 to 12 weeks from receipt of approved quote, deposit, and confirmed colour selections.

Important Notes

- Client is responsible for installation in accordance with manufacturer specifications and local requirements.
- Client must provide colour selections for all metal structures and plastic components prior to manufacturing.
- ActiveFit outdoor fitness equipment is intended for users aged 13 years and older.

ActiveFit Statement of Warranty

If any ActiveFit Outdoor Fitness Exercise Station fails due to defects in materials or workmanship, and subject to the specific warranty periods and exclusions stated below, Active Playground Equipment Inc. (APE) will, at its discretion and through its authorized representative, repair or replace any components or parts found defective without charge.

10 Year Limited Warranty

- Metal support posts and non-moving secondary metal structural frames.
- High-density polyethylene (HDPE) including seats, backrests, footpads, pedals, and hand grips.
- Powder coated and painted finishes.
- Stainless steel fasteners
- Welds.

2 Year Limited Warranty

- Moving metal components.
- Pivot points shafts, bearings, and bushings.
- Ropes and cables.

Exclusions

Warranty claims will be compromised should any claim be the result of:

- Exercise equipment not assembled or installed according to APE's assembly and installation instructions.
- Exercise equipment not maintained according to APE's maintenance procedures.
- Misuse, negligence, vandalism, or accident.
- Cosmetic issues including wear and tear under normal use such as dents, scratches, marring, fading and discoloration, minor rusting, exposure to abrasive materials such as sand or pea stone, and/or exposure to saltwater.
- The addition or substitution of unauthorized components or parts.
- Exercise equipment having been modified, altered, or repaired by persons other than an APE authorized installer or representative which, in the judgement of Active Playground Equipment Inc. affects the condition or operation of the Exercise Station.

Shipping, handling, and installation charges are not included. All shipments are F.O.B. Point Edward, Ontario, Canada, freight prepaid and charged.

All warranties commence on the date of invoice to the end-user. Upon being notified promptly in writing of any defect, APE shall make available replacement parts or components within 30 days to its authorized representatives. Shipping, handling, and/or installation charges to the end-user are exclusively at the discretion of the authorized representative. Replacement components or parts will be warranted for the balance of the original warranty. APE does not authorize any employee, representative or any other person to assume on its behalf any other liability in connection with the sale or use of any ActiveFit Exercise Station.

THIS WARRANTY IS EXCLUSIVE AND IN LIEU OF ALL OTHER WARRANTIES, WHETHER EXPRESSED OR IMPLIED, INCLUDING BUT NOT LIMITED TO ANY WARRANTY OF MERCHANTABILITY OR OF FITNESS FOR A PARTICULAR PURPOSE.

Exclusions

Warranty claims will be compromised should any claim be a result of:

- Vandalism, abuse, misuse or accident.
- Normal cosmetic changes such as: scratches, dents, marring, fading, discolouration, cable fraying.
- Acts of God such as: hail, flooding, lightning, tornadoes, sandstorms, earthquakes, windstorms, etc.
- Environmental factors such as: windblown or human dispersed aggregates, salt spray, saltwater.
- Normal wear and tear such as: Armour Coat and Cushion Guard wear in access/egress areas.
- Failure to maintain in accordance with Active Playground Equipment Inc. maintenance guide and CSA requirements.
- Improper Installation: When installed by a party other than an Active Playground Equipment Inc. authorized installer.
- Unauthorized additions, alterations or repairs by a party other than Active Playground Equipment Inc.
- Unintentional CSA (ASTM) non-compliance oversight was not reported within 12 months after the date of invoice.
- Other regulatory requirements or inspector comments that exceed or are outside of the scope of CSA Z614 or ASTM 1487.

Conditions

The warranty period applies from the date of invoice. Third-Party Products: Warranties of products that are not manufactured directly by Active Playground Equipment Inc. are limited to the original equipment manufacturer's warranty terms.

SURFACES MANUAL



SURFACING MATERIAL
Page 13 of 30

	Safety Certified	Cleanliness	Maintenance	Accessibility	Aesthetic	Install Cost	Lifetime Cost
Concrete Pad	Green	Green	Green	Green	Green	Green	Green
Asphalt	Green	Green	Green	Green	Green	Green	Green
Artificial Turf	Green	Yellow	Yellow	Green	Green	Orange	Orange
Pour in Place Rubber	Green	Green	Yellow	Green	Green	Green	Yellow
Limestone Screening	Green	Orange	Orange	Yellow	Green	Orange	Orange
Engineered Wood Fiber	Green	Yellow	Orange	Yellow	Yellow	Orange	Orange

Use Sign Sample

MULTI-GRIP PULL-UP BARS

Instructions

1. Position yourself directly below the bar. Choose your preferred grip option.
2. Grab the bar.
3. Pull yourself up towards the bar, bringing your chin over the bar or as close to it as possible.
4. Lower yourself from the bar slowly, in a smooth controlled motion, back to start position.

1. Placez-vous en-dessous de la barre. Choisissez une position que vous préférez pour agripper la barre.
2. Agripper la barre.
3. Tirer votre corps vers le haut. Votre corps devrait se rapprocher de la barre.
4. Rapprocher votre menton au-dessus de la barre ou le plus près possible.
5. Lentement, de façon contrôlée, ramener votre corps à votre position initiale.

ACTIVEFIT.CA • 1.800.463.2361

Warnings

The use of this equipment is at your own risk and responsibility. Allow only one user per station at a time. This equipment is for healthy individuals over 13 years of age & is not recommended for people with pre-existing health conditions. While the equipment is in use, keep small children & others at a safe distance from all moving parts. Do not use this equipment when wet or without shoes. If abnormal pain occurs during exercise, stop immediately!

Attention

Seulement une personne à la fois. Utilisez cet équipement à votre propre risque. Soyez responsable. Cet équipement devrait être utilisé par des individus en bonne santé qui ont plus de 13 ans. Ce n'est pas recommandé aux personnes qui ont des conditions de santé préexistantes. Pendant que vous utilisez l'équipement, gardez les enfants et les autres à une distance sécuritaire (1m ou 3 pieds). N'utilisez pas l'équipement lorsqu'il est mouillé ou sans souliers. Si vous avez des douleurs anormales, arrêtez l'exercice immédiatement.

● Primary
● Primaire

● Secondary
● Secondaire

Your
LOGO
Here

MULTI-GRIP PULL-UP BARS

Instructions

1. Position yourself directly below the bar. Choose your preferred grip option.
2. Grab the bar.
3. Pull yourself up towards the bar, bringing your chin over the bar or as close to it as possible.
4. Lower yourself from the bar slowly, in a smooth controlled motion, back to start position.

1. Placez-vous en-dessous de la barre. Choisissez une position que vous préférez pour agripper la barre.
2. Agripper la barre.
3. Tirer votre corps vers le haut. Votre corps devrait se rapprocher de la barre.
4. Rapprocher votre menton au-dessus de la barre ou le plus près possible.
5. Lentement, de façon contrôlée, ramener votre corps à votre position initiale.

ACTIVEFIT.CA • 1.800.463.2361

Warnings

The use of this equipment is at your own risk and responsibility. Allow only one user per station at a time. This equipment is for healthy individuals over 13 years of age & is not recommended for people with pre-existing health conditions. While the equipment is in use, keep small children & others at a safe distance from all moving parts. Do not use this equipment when wet or without shoes. If abnormal pain occurs during exercise, stop immediately!

Attention

Seulement une personne à la fois. Utilisez cet équipement à votre propre risque. Soyez responsable. Cet équipement devrait être utilisé par des individus en bonne santé qui ont plus de 13 ans. Ce n'est pas recommandé aux personnes qui ont des conditions de santé préexistantes. Pendant que vous utilisez l'équipement, gardez les enfants et les autres à une distance sécuritaire (1m ou 3 pieds). N'utilisez pas l'équipement lorsqu'il est mouillé ou sans souliers. Si vous avez des douleurs anormales, arrêtez l'exercice immédiatement.

● Primary
● Primaire

● Secondary
● Secondaire

STRENGTH TRAINING GYM

Age Group: **13+**

Number of Users: **6**



All equipment comes complete with bilingual signs

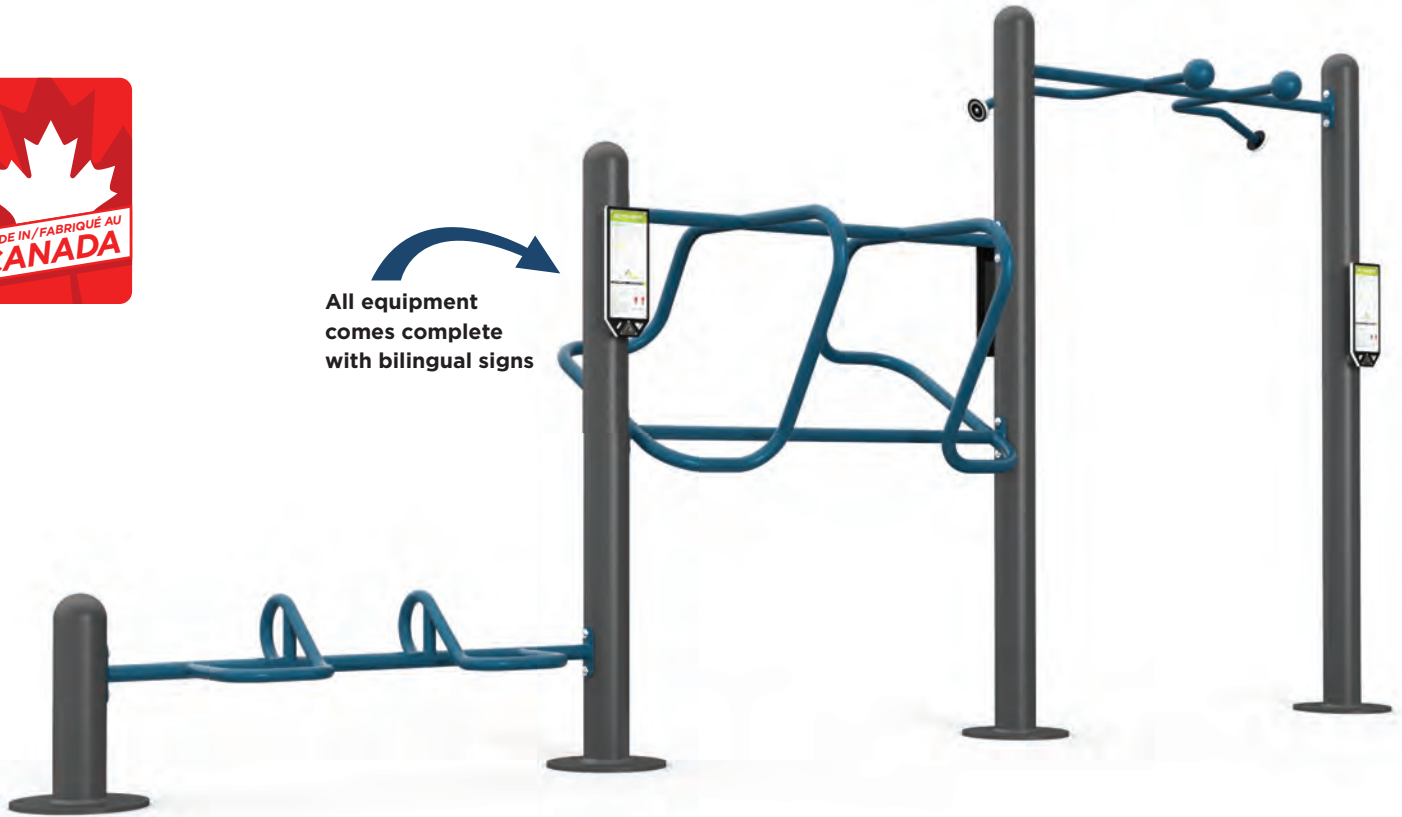

Multi-Grip Push-Up Bars

Multi-Grip Dip Station

Multi-Grip Pull-Up Bars



SPECIFICATIONS

Length:	38 in / 97 cm
Width:	193 in / 490 cm
Height:	90 in / 228 cm
Weight:	287 lb / 130 kg

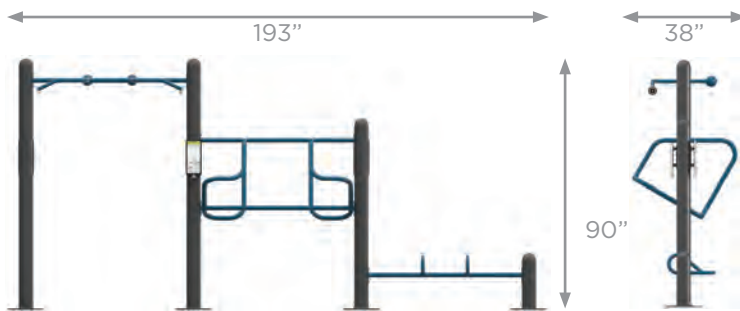

INSTALLATION

Installation Options: Concrete Pad Dimensions:

- ✓ Post in Concrete Length: 144 in / 366 cm
- ✓ Surface Mount Width: 216 in / 549 cm

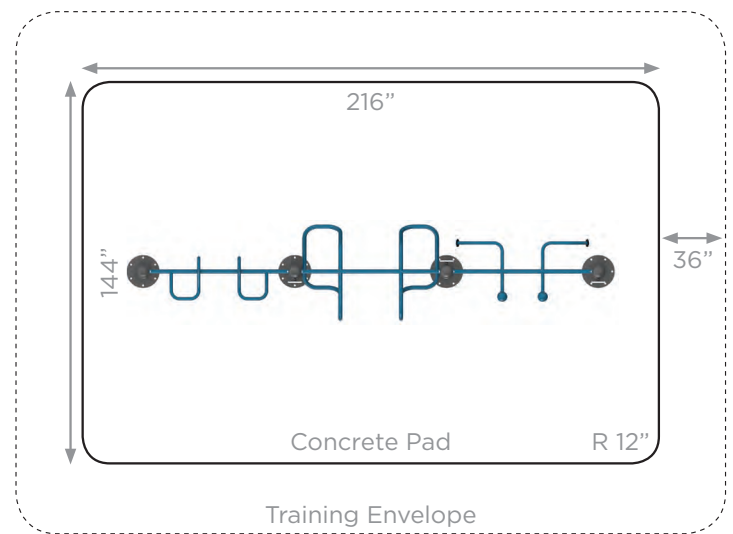

MATERIALS

- Powder coated, galvanized steel
- Tamper-proof 316 grade, stainless steel fasteners
- 3/4" (1.9cm) anti-static, high density polyethylene (HDPE), with UV stabilizers

WARRANTY

Visit activefit.ca for complete details.

10 Year Limited Warranty:

- Metal support posts and non-moving secondary metal structural frames, including welds.
- High density polyethylene (HDPE) and rotational molded components including seats, back rests, foot pads, pedals and hand grips
- Powder coated and painted finishes

2 Year Limited Warranty

- Moving metal components
- Pivot point shafts, bearings and bushings
- Ropes and cables

! For a more custom look, choose from one of our preset colour schemes, or speak with one of our experienced sales representatives to determine the best colour combination for your product.

*Active Playground Equipment has a policy of continuous product improvement for the benefit of our customers. We reserve the right to redesign, change specifications or discontinue products without written notice. Products on our website, in our printed literature and detailed in our quotations may differ from what is available at the time an order is placed. Please check with your Active Playground representative to confirm that the product you will receive is what you are expecting. Revised January 2018.

MULTI-GRIP PUSH-UP BARS

Age Group: **13+**

Number of Users: 

All equipment comes complete with bilingual signs



FEATURES

- Multiple grip configurations offer a range of difficulty options
- Vertical and horizontal bars increase range and motion of push-ups
- Minimal assembly required
- Various colours available
- Combo unit upgrade available

TRAINING

- Traditional Push-Up
- Wide Grip Push-Up
- Inclined Push-Ups
- Close or Wide Angled Grip Push-up
- Bench Dips



The ActiveFit **Push-Up Bars** are a classic outdoor fitness piece. This unit strengthens the shoulders, biceps, hand grip, back and chest. The ActiveFit **Push-Up Bars** are designed to offer users multiple options in push-up positions and level of difficulty.

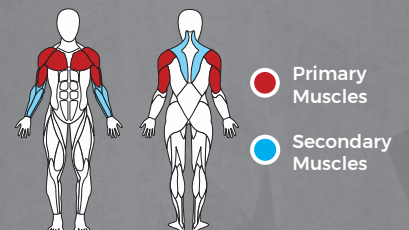
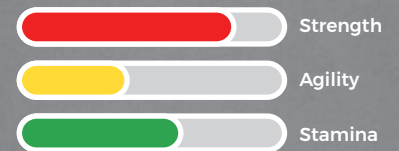
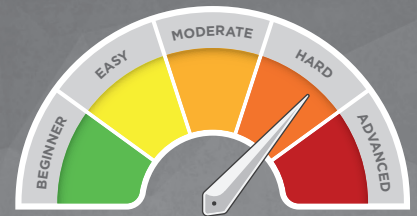

MULTI-GRIP DIP STATION

 Age Group: **13+**

Number of Users:



All equipment comes complete with bilingual signs

FEATURES

- Multiple grip and bar height options offer a wide range of difficulty and versatility
- Low impact - Great for seniors
- Minimal assembly required
- Various colours available
- Combo unit upgrade available

TRAINING

- Chest & Tricep Dips
- Body Triceps Press
- Assisted Body Weight Squats
- Assisted Push-Up
- Inverted Body Weight Rows
- Knee Lift/Leg Lift



The ActiveFit **Multi-Grip Dip Station** is used to perform dips, leg lifts, and stretching exercises. It is excellent for improving strength and flexibility, and is a great option for any senior looking to get more active. The unit allows users to perform multiple exercises on a single piece of equipment.

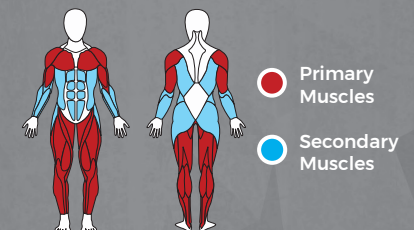
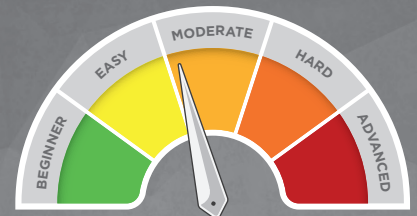

82" MULTI-GRIP PULL-UP BARS

Age Group: **13+**

Number of Users:



All equipment comes complete with bilingual signs

FEATURES

- Rounded hand grips improve grip strength
- Multiple grip options offer a range of difficulty and versatility
- Available in various heights: 82" & 92"
- Minimal assembly required
- Various colours available
- Combo unit upgrade available

TRAINING

- Pull-Up
- Parallel Bar Pull-Up
- Ball Grip Pull-Up
- Chin-Up



The ActiveFit **Multi-Grip Pull-Up Bars** are a versatile piece of equipment, perfect for strengthening the upper body. Multiple comfort grips allow for a variety of exercises.

The **Multi-Grip Pull-Up Bars** are the ultimate strength building and toning station, and are the perfect addition to any outdoor gym.



The difficulty gauge shows levels: BEGINNER (green), EASY (yellow), MODERATE (orange), HARD (red), and ADVANCED (dark red). A needle points to the MODERATE level.

Progress bars for: Strength (red), Agility (yellow), and Stamina (green).

Muscle activation diagram showing Primary Muscles (red) and Secondary Muscles (blue).



PARALLEL BARS

Age Group: **13+**

Number of Users: 

All equipment comes complete with bilingual signs

FEATURES

- Low impact - Great for seniors
- Multiple training options offer a range of difficulty and versatility
- Two bar heights accommodate multiple user types.
- Minimal assembly required
- Various colours available

TRAINING

- Shoulder Shrugs
- Support Travel
- Rear to Front Support Travel
- Support Jumps & Dips
- Shuttle Push-Up
- Knee/Leg Raises
- Assisted Body Weight Squats



The ActiveFit **Parallel Bars** are an essential piece for a variety of upperbody strength and stretching exercises. This sturdy equipment is also a standard in physical therapy environments, making it a perfect piece for seniors.

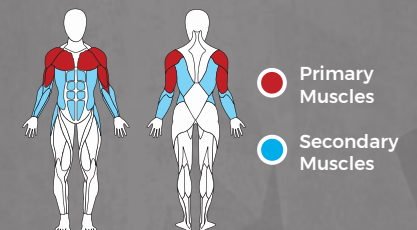
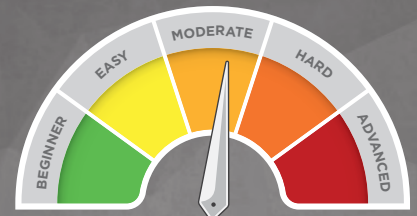

SPECIFICATIONS

Length:	126 in / 320 cm
Width:	95 in / 242 cm
Height:	63 in / 160 cm
Weight:	356 lb / 162 kg

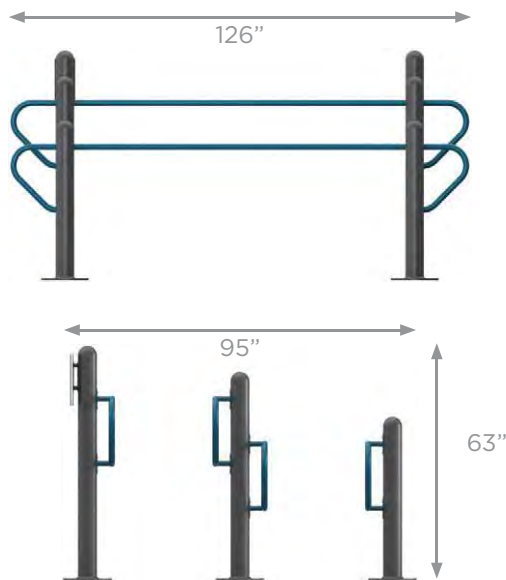

INSTALLATION

Installation Options: Concrete Pad Dimensions:

- ✓ Post in Concrete
 - ✓ Surface Mount
- Length: 132 in / 336 cm
Width: 180 in / 458 cm

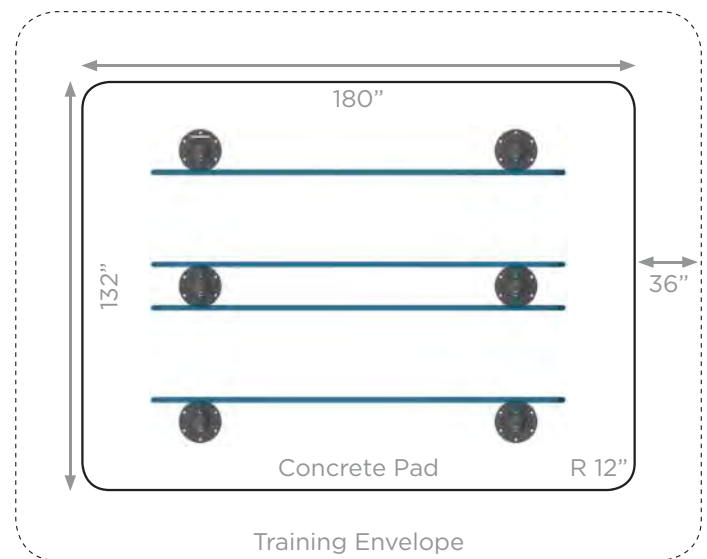

MATERIALS

- Powder coated, galvanized steel
- Tamper-proof 316 grade, stainless steel fasteners
- 3/4" (1.9cm) anti-static, high density polyethylene (HDPE), with UV stabilizers

WARRANTY Visit activefit.ca for complete details.

10 Year Limited Warranty:

- Metal support posts and non-moving secondary metal structural frames, including welds.
- High density polyethylene (HDPE) and rotational molded components including seats, back rests, foot pads, pedals and hand grips
- Powder coated and painted finishes

2 Year Limited Warranty

- Moving metal components
- Pivot point shafts, bearings and bushings
- Ropes and cables

For a more custom look, choose from one of our preset colour schemes, or speak with one of our experienced sales representatives to determine the best colour combination for your product.

*Active Playground Equipment has a policy of continuous product improvement for the benefit of our customers. We reserve the right to redesign, change specifications or discontinue products without written notice. Products on our website, in our printed literature and detailed in our quotations may differ from what is available at the time an order is placed. Please check with your Active Playground representative to confirm that the product you will receive is what you are expecting. Revised January 2018.

TOTAL CORE STATION

Age Group: **13+**

Number of Users: 

FEATURES

- Combines both the Sit-Up and Hyper-Extension Bench to create a total core training solution
- Metal foot plate for added grip and durability
- Minimal assembly required
- Various colours available

TRAINING

- Back Extensions
- Inclined Oblique Crunches
- Side Crunches
- Inclined Leg Raises
- Declined Sit-Ups
- Declined Twisting Sit-Ups

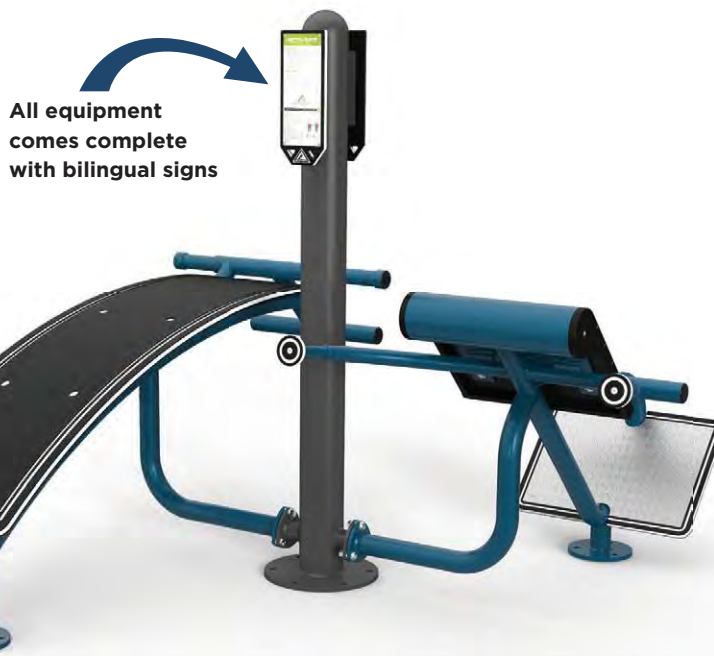

The ActiveFit **Sit Up Bench** is a compact and efficient piece of equipment designed to strengthen abdominal muscles and improve core fitness.

The ActiveFit **Hyper-Extension Bench** is designed to help improve core strength, while developing abs and back muscles.

Designed with a small overall footprint, this is a must have for any serious outdoor fitness park.

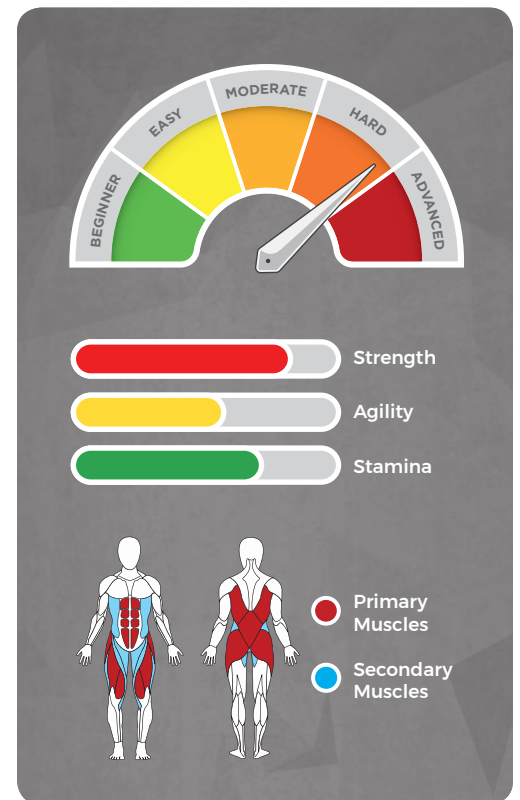
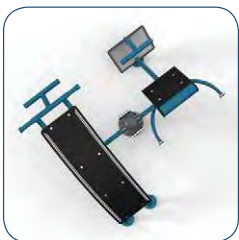

SPECIFICATIONS

Length:	81 in / 206 mm
Width:	87 in / 220 mm
Height:	63 in / 160 mm
Weight:	288 lb / 131 kg

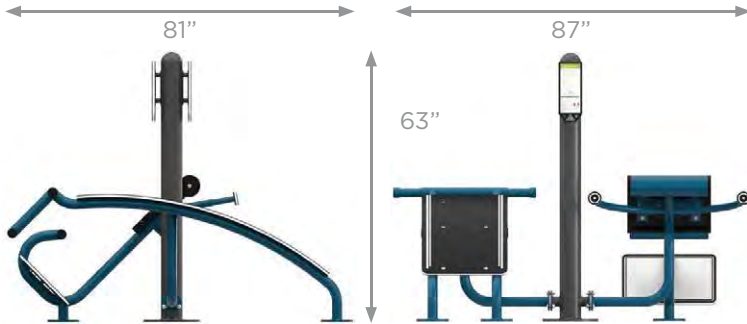

INSTALLATION

Installation Options: Concrete Pad Dimensions:

- ✓ Post in Concrete Length: 108 in / 275 cm
- ✓ Surface Mount Width: 118 in / 300 cm

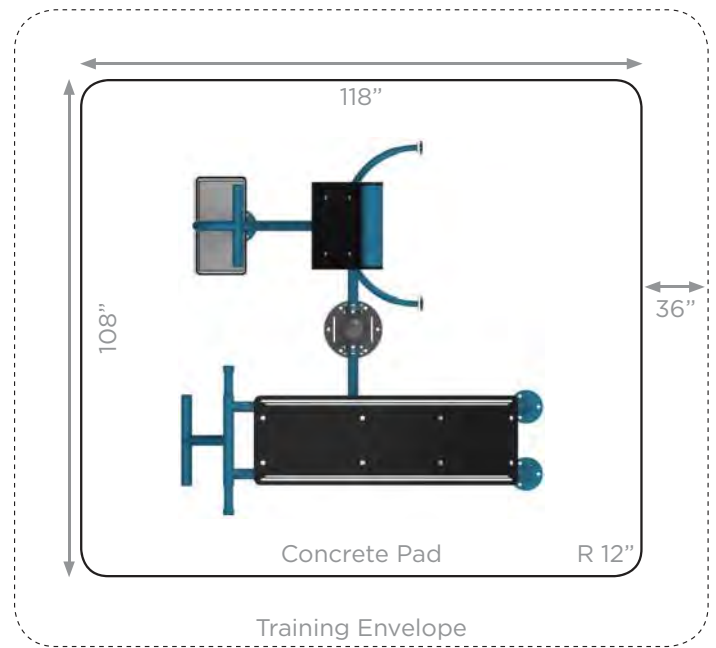

MATERIALS

- Powder coated, galvanized steel
- Tamper-proof 316 grade, stainless steel fasteners
- 3/4" (1.9cm) anti-static, high density polyethylene (HDPE), with UV stabilizers

WARRANTY Visit activefit.ca for complete details.

10 Year Limited Warranty:

- Metal support posts and non-moving secondary metal structural frames, including welds.
- High density polyethylene (HDPE) and rotational molded components including seats, back rests, foot pads, pedals and hand grips
- Powder coated and painted finishes

2 Year Limited Warranty

- Moving metal components
- Pivot point shafts, bearings and bushings
- Ropes and cables

! For a more custom look, choose from one of our preset colour schemes, or speak with one of our experienced sales representatives to determine the best colour combination for your product.

*Active Playground Equipment has a policy of continuous product improvement for the benefit of our customers. We reserve the right to redesign, change specifications or discontinue products without written notice. Products on our website, in our printed literature and detailed in our quotations may differ from what is available at the time an order is placed. Please check with your Active Playground representative to confirm that the product you will receive is what you are expecting. Revised January 2018.

KNEE LIFT / PULL-UP STATION

 Age Group: **13+**

Number of Users:



All equipment comes complete with bilingual signs

FEATURES

- Multiple training options offer users a range of difficulty and versatility
- Small installation footprint
- Minimal assembly required
- Various colours available
- 3/4" UV resistant high density polyethylene

TRAINING

- Pull-Up / Chin-Up
- Parallel Bar Pull-Up
- Knee Lift Crunches
- Dips
- Leg Lifts



The ActiveFit **Knee Lift / Pull-Up Station** is a multi-purpose product used to perform pull-ups, dips, leg lifts and stretching exercises. This piece is great for both novice and more advanced users. The ActiveFit Knee Lift is also available with a Stepper combo.

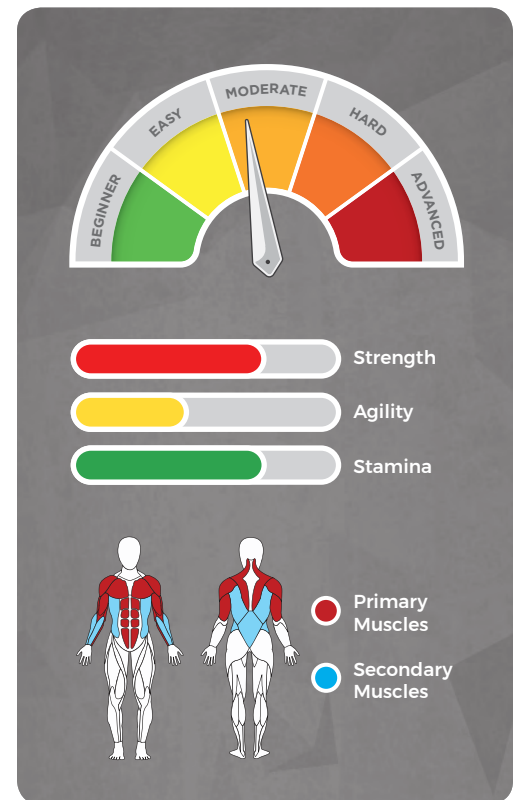

KNEE LIFT / PULL-UP STATION



SPECIFICATIONS

Length:	65 in / 164 cm
Width:	41 in / 104 cm
Height:	88 in / 223 cm
Weight:	128 lb / 58 kg



INSTALLATION

Installation Options: Concrete Pad Dimensions:

- ✓ Post in Concrete Length: 84 in / 214 cm
- ✓ Surface Mount Width: 102 in / 259 cm

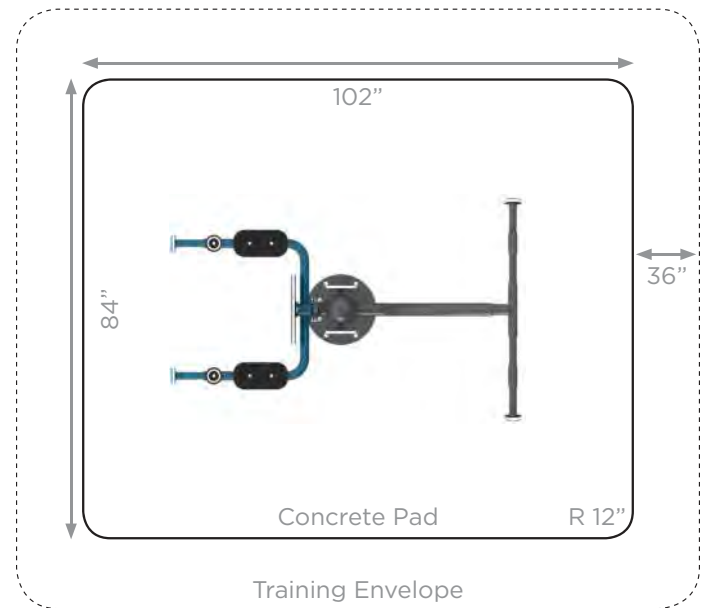

MATERIALS

- Powder coated, galvanized steel
- Tamper-proof 316 grade, stainless steel fasteners
- 3/4" (1.9cm) anti-static, high density polyethylene (HDPE), with UV stabilizers

WARRANTY Visit activefit.ca for complete details.

10 Year Limited Warranty:

- Metal support posts and non-moving secondary metal structural frames, including welds.
- High density polyethylene (HDPE) and rotational molded components including seats, back rests, foot pads, pedals and hand grips
- Powder coated and painted finishes

2 Year Limited Warranty

- Moving metal components
- Pivot point shafts, bearings and bushings
- Ropes and cables

! For a more custom look, choose from one of our preset colour schemes, or speak with one of our experienced sales representatives to determine the best colour combination for your product.

*Active Playground Equipment has a policy of continuous product improvement for the benefit of our customers. We reserve the right to redesign, change specifications or discontinue products without written notice. Products on our website, in our printed literature and detailed in our quotations may differ from what is available at the time an order is placed. Please check with your Active Playground representative to confirm that the product you will receive is what you are expecting. Revised January 2018.

PLYOMETRIC STEPS

Age Group: **13+**

Number of Users: 



The ActiveFit **Plyometric Steps** provide basic yet effective training for a variety of intense exercises, aerobics and stretches. This product tests and develops physical coordination and agility, providing a low impact, leg strengthening, training exercise with varying degrees of difficulty.

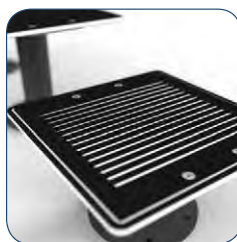
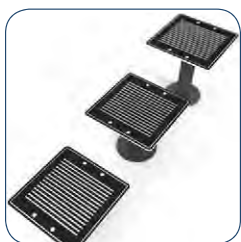

FEATURES

- Three step heights accommodate various skill levels.
- Multiple training options offer a range of difficulty and versatility
- Various installation configurations
- Various colours available
- Free standing use sign to suit any installation

TRAINING

- Linear Stabilization Jumps
- Lateral Stabilization Jumps
- Step-Ups / Jumps
- Lateral Step Downs
- Elevated Push-Ups

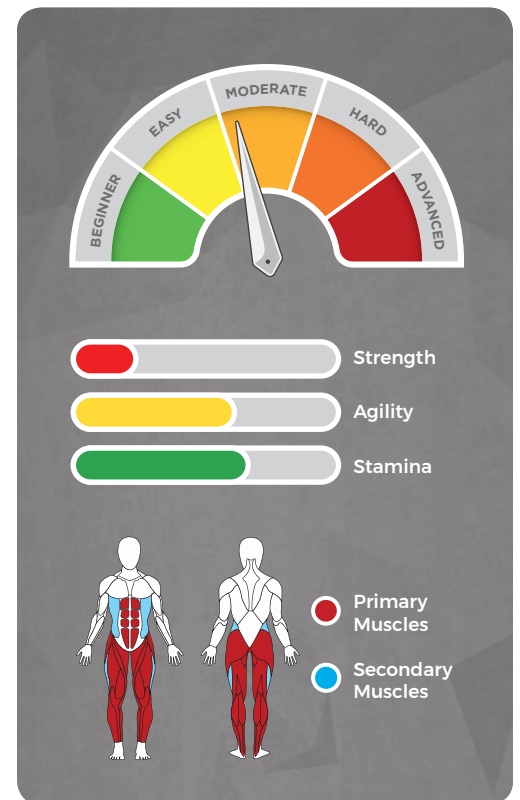

SPECIFICATIONS

Length:	82 in / 209 cm
Width:	63 in / 160 cm
Height:	60 in / 153 cm
Weight:	182 lb / 83 kg

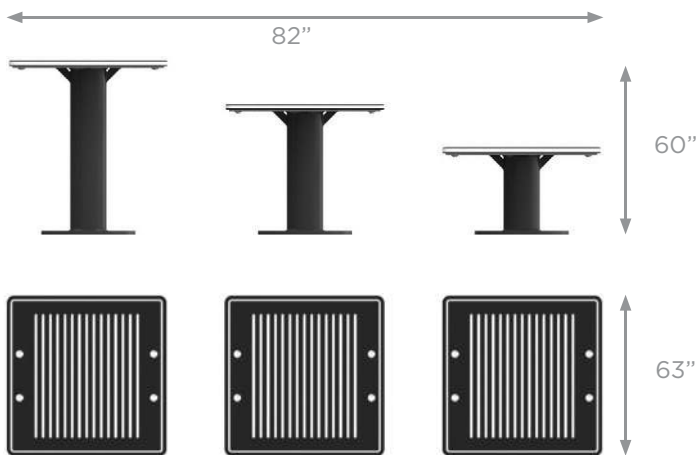

INSTALLATION

Installation Options: Concrete Pad Dimensions:

- ✓ Post in Concrete Length: 130 in / 331 cm
- ✓ Surface Mount Width: 144 in / 366 cm

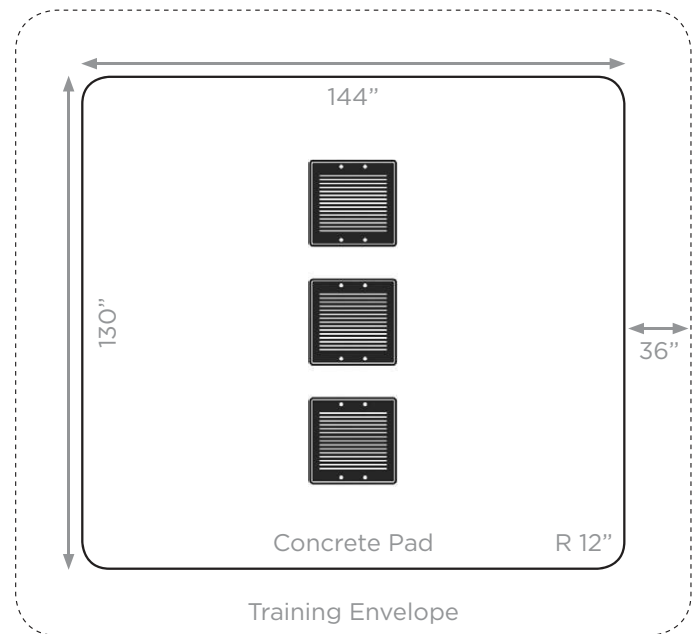

MATERIALS

- Powder coated, galvanized steel
- Tamper-proof 316 grade, stainless steel fasteners
- 3/4" (1.9cm) anti-static, high density polyethylene (HDPE), with UV stabilizers

WARRANTY

Visit activefit.ca for complete details.

10 Year Limited Warranty:

- Metal support posts and non-moving secondary metal structural frames, including welds.
- High density polyethylene (HDPE) and rotational molded components including seats, back rests, foot pads, pedals and hand grips
- Powder coated and painted finishes

2 Year Limited Warranty

- Moving metal components
- Pivot point shafts, bearings and bushings
- Ropes and cables

For a more custom look, choose from one of our preset colour schemes, or speak with one of our experienced sales representatives to determine the best colour combination for your product.

*Active Playground Equipment has a policy of continuous product improvement for the benefit of our customers. We reserve the right to redesign, change specifications or discontinue products without written notice. Products on our website, in our printed literature and detailed in our quotations may differ from what is available at the time an order is placed. Please check with your Active Playground representative to confirm that the product you are purchasing is what you are expecting. Revised January 2018.



Township of Springwater Municipal & School Board Election Election Day - October 26, 2026

To:	All Township Departments, Community Recreation Associations, Township of Springwater Committees, Elmvale Business Improvement Area, Springwater Public Library, and Springwater Farmers Market – Elmvale
From:	Renée Ainsworth, Clerk
Date:	April 21, 2026
Re:	2026 Municipal Elections – Campaigning at Municipal Events or on Municipal Property

As we head into the 2026 election season, please be advised that there are restrictions surrounding political campaigning and partisan activities at all Township sanctioned/hosted event as well as on any Township property.

As a department, committee or board of the Township of Springwater, any event you host is considered a Township sanctioned/hosted event. As such, the following regulations and restrictions are in place until October 26, 2026:

- Political Campaigning and Partisan Activities are prohibited at all events. Campaigning means: working in an organized and active way towards a particular candidate(s) or the election in general and includes any materials (buttons, t-shirts, signs, flyers etc) at the event or event grounds; rental of space or booth at an event for campaign purposes; stopping or actively seeking out attendees for campaign purposes. These restrictions also apply to Third-Party Advertisers, who are registered with the Township to provide paid advertisements relating to the election. Township of Springwater election officials are exempt and shall be permitted to promote election information for electors at Township events.
- Political Campaigning or Partisan Activities is restricted from being conducted at a committee or board meeting. **This includes soliciting endorsement signatures.**
- Township Departments, Committees and Boards are prohibited from hosting a Candidate Debate, promoting such debate or providing funding towards a debate. Any debates must be organized by non-Township groups and organizations.

- Campaign or political materials are not permitted to be placed within a Township facility, software, program, website or printed materials. This includes the Administration Centre, Community Halls, the Arena, Township Yards and their properties. This also includes any websites, social media and electronic mail or printed material. The Elmvale Library shall be exempt and allow all candidates to place campaign materials in a pre-determined location within each of its branches, at the discretion of the Library CEO.
- Everyone is encouraged to share or post Township election materials, including the Unofficial/Certified List of Candidates, Voters Information or general election information. Approved information can be found on the Township website at www.springwater.ca/elections.
- Candidates may only undertake campaigning on Township properties/facilities provided they have paid full-market rental fees and rates for use of such facilities and have otherwise complied with any other Township of Springwater policy pertaining to the use of such facilities. The Administration Centre, located at 2231 Nursery Rd shall not be rented for any campaigning purposes.

The Township Election Team is looking for opportunities to conduct general election education/voter registration at upcoming events. If your committee or board/CRA is hosting an event before October 26th, please let the Clerks team know. If each group could provide us with a list of their events, and how to request a booth/table, it would be greatly appreciated.

Non-Township Events:

Campaigning at a non-Township event is at the discretion of the event organizers.

If you have any questions about the above, please do not hesitate to contact a members of the Clerks Department at clerks@springwater.ca or via telephone at 705-728-4784 x 2304.